

Article number: 03509070

Description: Fluro Rod end GE 70SX

Measures

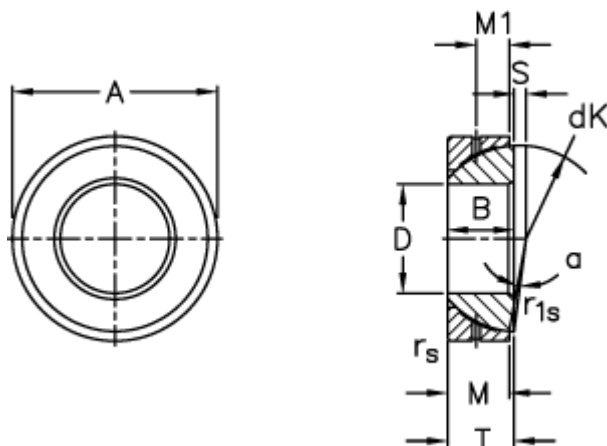

A	= 110 0 -0,018	S	= 7.2
B	= 25	Static load C0 (kN)	= 1040
D	= 70 0 -0,015	T	= 25 +0,25 -0,50
dK	= 102	Tilt angle	= 2
Dynamic load C (kN)	= 208	Weight	= 1040
M	= 23		
M1	= 12.5		
rs, r1s min	= 1.1		